

MODEL NO. : LRM- 1512

□ SPECIFICATION □

LCD Panel Type	15 " TFT (Diagonal)
Displayable Resolution	1024 x 768 maximum
LCD Display Color	262,144 colors
Viewing Angle	Horizontal: L/R 60° Vertical : H/L 45°
Contrast Ratio	400 : 1
Brightness	250 cd/m2
Response Time	4ms
Control Function (Panel)	Power On/Off
Control Function	Brightness, contrast, Color, Volume, Mute
Power Source :	AC/DC Adapter 12V DC.
Input Signal	Audio / Video Composite: NTSC/PAL/SECAM 1 Vp-p. 75 ohms x1 S-Video socket x 1 PC RGB Analogue : 15 Pin D-Sub x1 VESA DDC2B
Plug & Play	
Regulations	Safety: CE, FCC meet
Dimensions (LxWxD)	486.0 X 304.0 X 52.0 mm
Weight	8 Kgs
Temperature	Operation: 5°C ~ 35 °C Storage :-5°C ~60 °C

FEATURES

1. 15" LCD Screens
2. 2 Video RCA Inputs
3. 1 Audio RCA Output
4. Low Power Consumption
5. Can rotate side brackets to adjust the required Viewing angle

REVISION				
ISSUE	ZONE	DESCRIPTION	DATE	REVISER

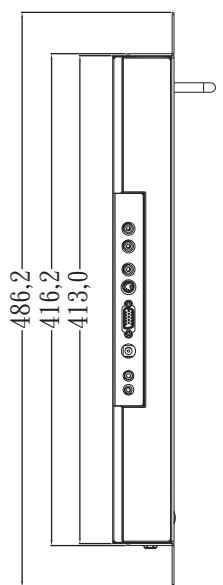
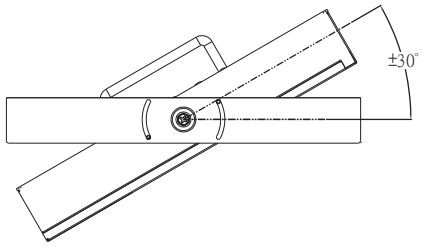
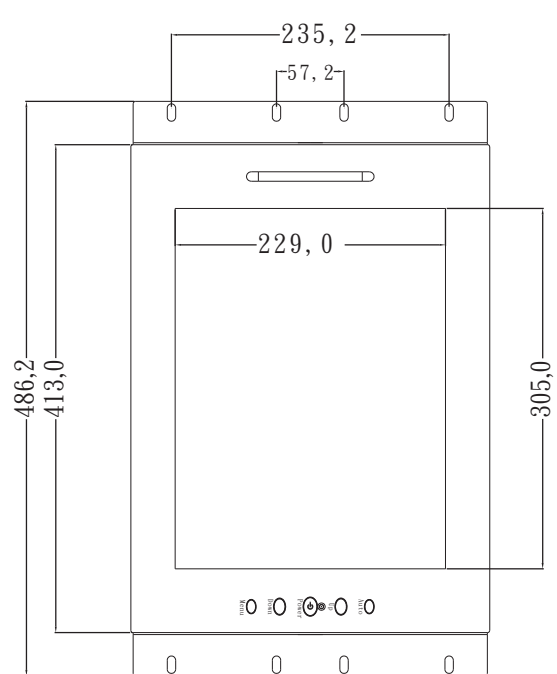
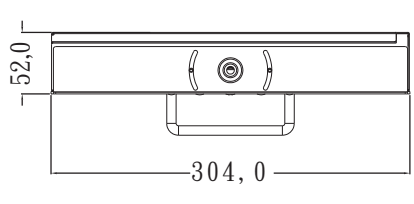
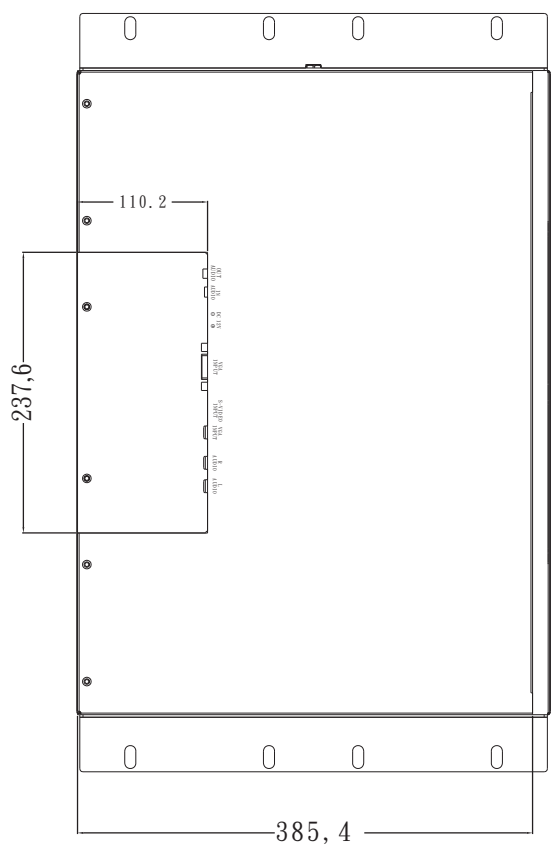
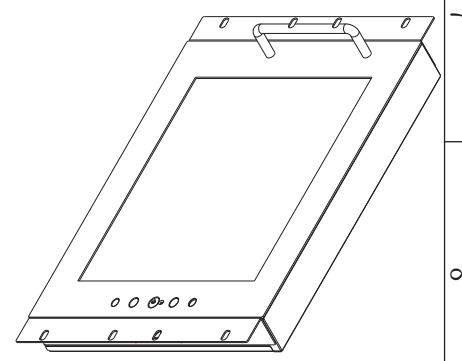
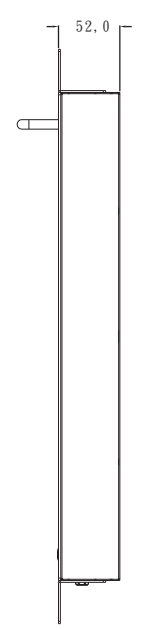

1	2	3	4	5	6	7	8
VIEW TEK [®]							
LEE MING INDUSTRIAL CO.,LTD							
DESIGN		MODEL NO.		PARTS NO.		PARTSNAME	
		LRM -1512				LRM -1512	
		CHECKED		APPROVED		DRAWING NO.	
		DW.G.DATE		MATERIAL		UNIT	
		2008/09/05				mm	
		REV.DATE		SCALE		REV	